

# LEGEND<sub>NX</sub>

## LGNXDO4KIQWF

### 4K Dome Network Camera with IQ, Fixed Lens

- 8MP High-Resolution Imaging
- High IQ: Extreme AI Analytics
- Improve human and vehicle classification using deep learning
- 120 dB true WDR Technology
- Water and dust resistant (IP67)
- Vandal Proof (IK10)
- Built-in microphone for live audio
- Advanced H.265+ Compression



### In short

8MP high-resolution surveillance camera with extreme AI analytics and active deterrence featuring red and blue lights. Equipped with deep learning for enhanced human and vehicle classification, 120 dB true WDR technology, IP67 water and dust resistance, IK10 vandal protection, built-in microphone for live audio, and advanced H.265+ compression.

### Dimensions

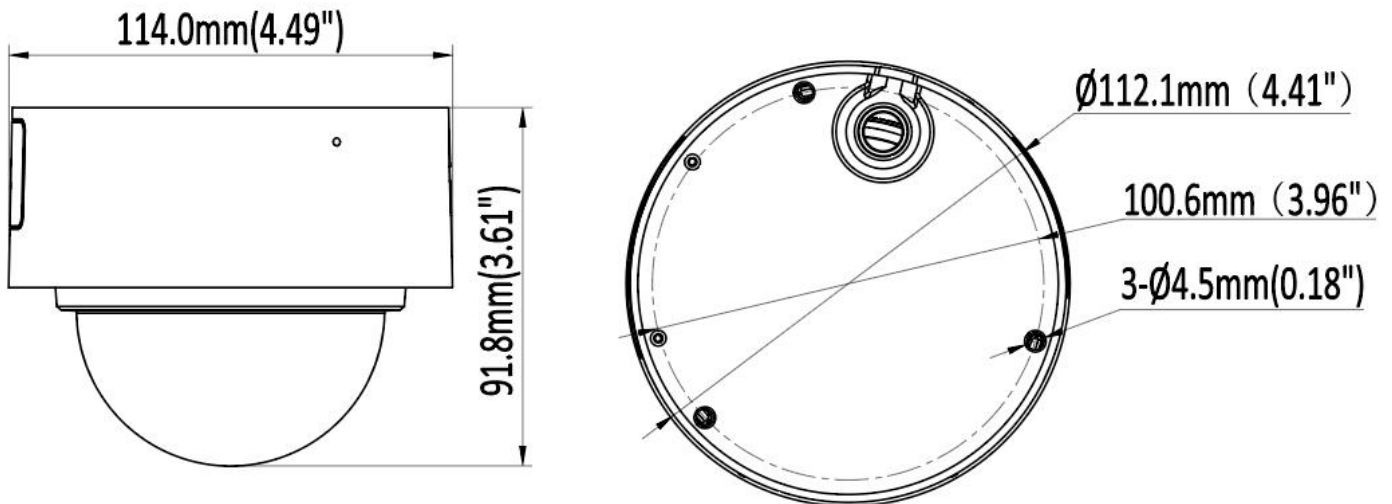

\*Design and specifications are subjects to change without notice.

## Technical Specifications

Camera: LGNXDO4KIQWF				
Image Sensor	1/2.8" Progressive Scan CMOS Sensor			
Minimum Illumination	Color: 0.006 Lux (F1.6 , AGC ON) , 0 Lux with light			
Illumination Distance	30m / 98.43ft (IR light)			
Strobe Light	Supported			
Smart IR	Supported			
Pan / Tilt / Rotation Range	Pan: 0° ~ 355° Tilt: 0° ~ 75° Rotation: 0° ~ 355°			
Lens				
Focal Length	2.8mm			
Aperture	F1.6			
Field of View	2.8mm: Horizontal FOV: 106°, Vertical FOV: 58°, Diagonal FOV: 125°			
Lens Mount	M12			
DORI 2.8mm	Detection	Observe	Recognize	Identify
	88m	34.7m	17.4m	8.7m
Camera Image				
Maximum Resolution	8MP (3840 × 2160)			
Main Stream	50Hz: 25fps 8MP (3840 × 2160), 25fps 6MP ( 3200 × 1800), 25fps 5MP (3072 × 1728), 25fps 4MP (2560 × 1440), 25fps 1080P (1920 × 1080)			
	60Hz: 30fps 8MP (3840 × 2160), 30fps 6MP (3200 × 1800), 30fps 5MP (3072 × 1728), 30fps 4MP (2560 × 1440), 30fps 1080P (1920 × 1080)			
Sub Stream	50Hz: 25fps 720P (1280 × 720), 25fps D1 (704 × 576), 25fps CIF (352 × 288) (Default D1)			
	60Hz: 30fps 720P (1280 × 720), 30fps D1 (704 × 480), 30fps CIF (352 × 240)			
Third Stream	50Hz: 25fps CIF (352 × 288)			
	60Hz: 30fps CIF (352 × 240)			
Image Setting	Brightness / Contrast / Saturation / Hue / Sharpness			
Shutter Time	Auto/Manual, 1/3 ~ 1/100000s			
Day/Night	IR Cut Filter			
Wide Dynamic Range	120 dB			
Digital Noise Reduction	2D/3D DNR			
BLC	Supported			
HLC	Supported			
ROI	Supported			
Rotate	Supported			
Compression				
Video Compression	H.264 / H.264+ / H.265 / H.265+ / MJPEG			
H.264 Codec Profile	Base / Main / High profile			
H.265 Codec Profile	Main Profile			
Video Bit Rate	11 Kbps ~ 16 Mbps			
Triple Streams	Supported			
Audio Compression	G.711A, G.711U			
Audio Bit Rate	64 Kbps			

\*Design and specifications are subjects to change without notice.

## Technical Specifications

Smart Features	
Basic Events	Motion Detection (supports alarm activation based on designated target types, including humans and vehicles), Video Tampering
Smart Events	Smart Motion Detection, Line Crossing, Intrusion Detection, Monitoring entry and exit for specific regions (with alarm triggers for the detection of humans and vehicles), Scene Alteration Detection
Face Detection	Supported
Network	
Network Storage	NAS (NFS, SMB/CIFS), ANR
Protocols	TCP/IP, ICMP, HTTP, HTTPS, FTP, DHCP, DNS, DDNS, RTP, RTSP, RTCP, NTP, IGMP, UPnP, SMTP, UPnP-TM, P2P
System Compatibility	Onvif (Profile S, Profile G, T), SDK
Security	Password protection, complex passwords, HTTPS encryption, IP address filtering, basic and digest authentication for HTTP/HTTPS, TLS 1.1/1.2, WSSE and digest authentication for Open Network Video Interface
Users	Maximum 40 users
Web Browsers	Plug-in required live view: IE 10, IE 11 Local service: Chrome 57.0+, Firefox 52.0+
Mobile Surveillance	iOS, Android
Hardware	
Communication interface	1 RJ45 10 M/100 M self-adaptive Ethernet port
Storage	Up to 256GB
Microphone	Supported
Speaker	N/A
Audio I/O	N/A
Alarm I/O	N/A
Reset button	Supported
General	
Operating Conditions	-40°C ~ 60°C (-40°F ~ 140°F) Humidity 95% or less (non-condensing)
Power Supply	DC12V ± 25%
PoE	PoE (802.3 af)
Power Consumption	Less than 9W
Protection Level	IP67
IK Rating	IK10
Material	Metal
Dimensions	Φ 114 × 91.8 mm (Φ 4.49" × 3.61")
Gross Weight	1.76lb / 800g

\*Design and specifications are subjects to change without notice.

# What you may need



**XLGNXLB10**  
Junction Box  
Φ112.5 mm × 49.5mm



**XLGNXPM03**  
Pole Mount  
Φ170mm × 135.8mm × 43.7mm



**XLGNXLB14C**  
Wall Mount  
Φ120mm × 105.8mm x 183.5mm



**XLGNXCM700**  
Pendant Mount Bracket  
Φ116 mm × 734.5 mm

## Accessories Mount

**XLGNXLB10**

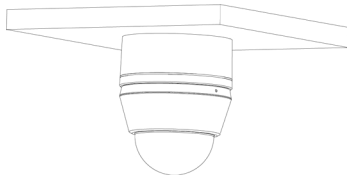

**XLGNXLB14C**

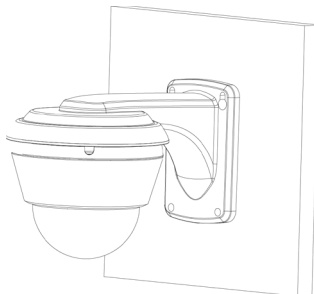

**XLGNXLB10 +  
XLGNXLB14C**

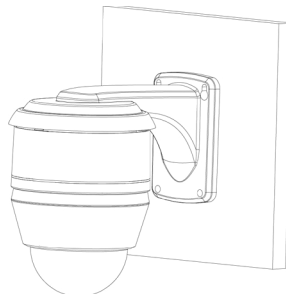

**XLGNXLB10 +  
XLGNXCM700**

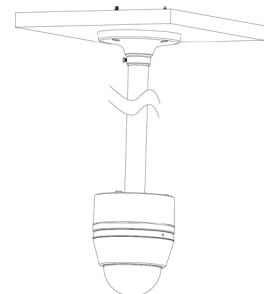

**XLGNXPM03**

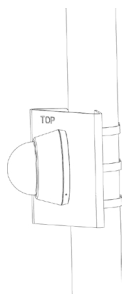

**XLGNXPM03 +  
XLGNXLB14C**



**XLGNXPM03 +  
XLGNXLB10**

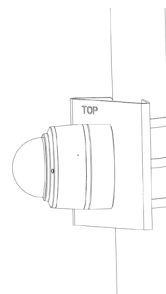

**XLGNXPM03 + XLGNXLB10  
+ XLGNXLB14C**

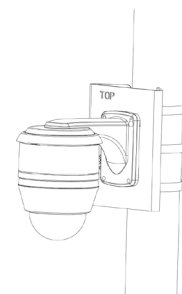

\*Design and specifications are subjects to change without notice.